

XXW70N07

70V N-Channel MOSFET

Features:

- Low Intrinsic Capacitances.
- Excellent Switching Characteristics.
- Extended Safe Operating Area.
- Unrivalled Gate Charge : $Q_g = 35\text{ nC}$ (Typ.).
- $BVDSS = 70\text{V}, I_D = 70\text{A}$
- $R_{DS(on)} : 8.6\text{m}\Omega$ (Max) @ $V_G = 10\text{V}$
- 100% Avalanche Tested

TO-252

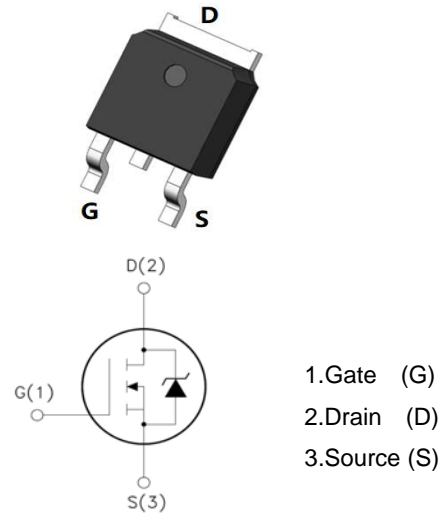

Absolute Maximum Ratings ($T_A = 25^\circ\text{C}$ unless otherwise noted)

Symbol	Parameter	Max.	Units
V_{DSS}	Drain-Source Voltage	70	V
V_{GSS}	Gate-Source Voltage	± 20	V
I_D	Continuous Drain Current	$T_C = 25^\circ\text{C}$	70
		$T_C = 100^\circ\text{C}$	52
I_{DM}	Pulsed Drain Current ^{note1}	320	A
EAS	Single Pulsed Avalanche Energy ^{note2}	121	mJ
P_D	Power Dissipation	$T_C = 25^\circ\text{C}$	116
$R_{\theta JC}$	Thermal Resistance, Junction to Case	0.85	$^\circ\text{C/W}$
T_J, T_{STG}	Operating and Storage Temperature Range	-55 to +175	$^\circ\text{C}$

Electrical Characteristics (TA=25°C unless otherwise noted)

Symbol	Parameter	Test Condition	Min.	Typ.	Max.	Units
Off Characteristic						
$V_{(BR)DSS}$	Drain-Source Breakdown Voltage	$V_{GS}=0V, I_D=250\mu A$	70	-	-	V
I_{DSS}	Zero Gate Voltage Drain Current	$V_{DS}=70V, V_{GS}=0V,$	-	-	1.0	μA
I_{GSS}	Gate to Body Leakage Current	$V_{DS}=0V, V_{GS}=\pm 20V$	-	-	± 100	nA
On Characteristics						
$V_{GS(th)}$	Gate Threshold Voltage	$V_{DS}=V_{GS}, I_D=250\mu A$	2	3	4	V
$R_{DS(on)}$	Static Drain-Source on-Resistance <small>note3</small>	$V_{GS}=10V, I_D=30A$	-	6.6	8.6	m Ω
Dynamic Characteristics						
C_{iss}	Input Capacitance	$V_{DS}=30V, V_{GS}=0V,$ $f=1.0MHz$	-	4062	-	pF
C_{oss}	Output Capacitance		-	261	-	pF
C_{rss}	Reverse Transfer Capacitance		-	231	-	pF
Q_g	Total Gate Charge	$V_{DS}=30V, I_D=30A,$ $V_{GS}=10V$	-	35	-	nC
Q_{gs}	Gate-Source Charge		-	11	-	nC
Q_{gd}	Gate-Drain("Miller") Charge		-	09	-	nC
Switching Characteristics						
$t_{d(on)}$	Turn-on Delay Time	$V_{DS}=30V, I_D=20A,$ $R_G=6.0\Omega, V_{GS}=10V$	-	9	-	ns
t_r	Turn-on Rise Time		-	7	-	ns
$t_{d(off)}$	Turn-off Delay Time		-	40	-	ns
t_f	Turn-off Fall Time		-	15	-	ns
Drain-Source Diode Characteristics and Maximum Ratings						
I_S	Maximum Continuous Drain to Source Diode Forward Current		-	-	70	A
I_{SM}	Maximum Pulsed Drain to Source Diode Forward Current		-	-	280	A
V_{SD}	Drain to Source Diode Forward Voltage	$V_{GS}=0V, I_S=30A$	-	-	1.2	V
t_{rr}	Body Diode Reverse Recovery Time	$I_F=20A, di/dt=100A/\mu s$	-	78	-	ns
Q_{rr}	Body Diode Reverse Recovery Charge		-	51	-	nC

Notes:1. Repetitive Rating: Pulse Width Limited by Maximum Junction Temperature

2. EAS condition : $T_J=25^\circ C, V_{DD}=30V, V_G=10V, L=0.5mH, R_g=25\Omega, I_{AS}=26A$

3. Pulse Test: Pulse Width $\leq 300\mu s$, Duty Cycle $\leq 0.5\%$

Typical Characteristics

Figure 1: Output Characteristics

Figure 2: Typical Transfer Characteristics

Figure 3: On-resistance vs. Drain Current

Figure 4: Body Diode Characteristics

Figure 5: Gate Charge Characteristics

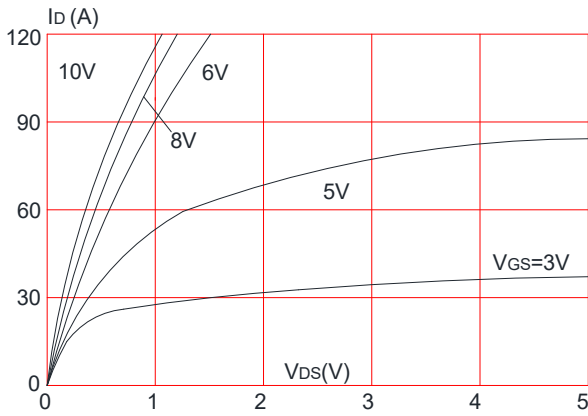
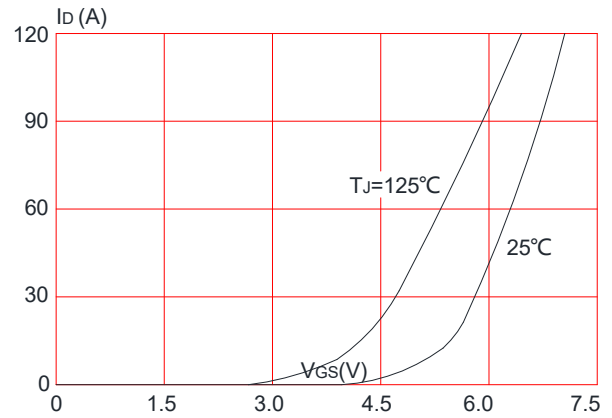
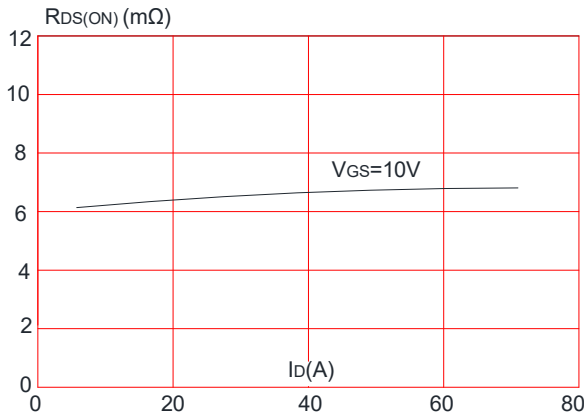
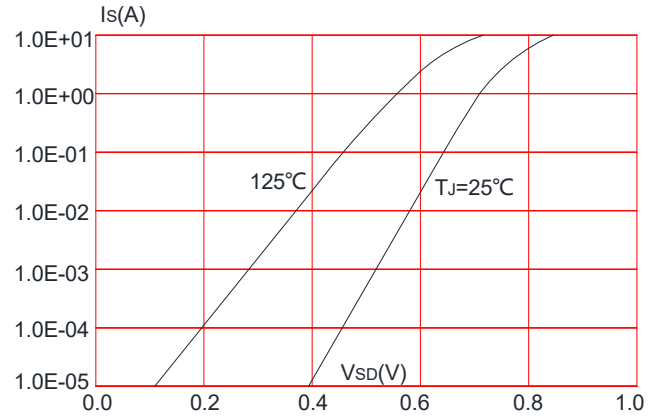
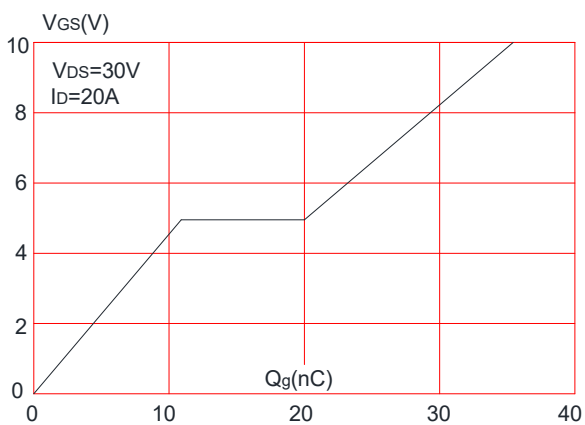
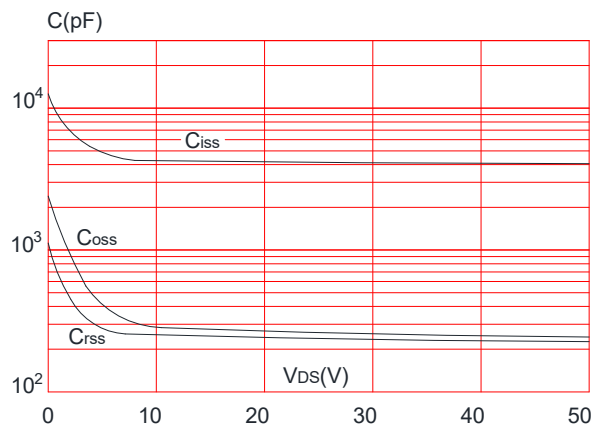
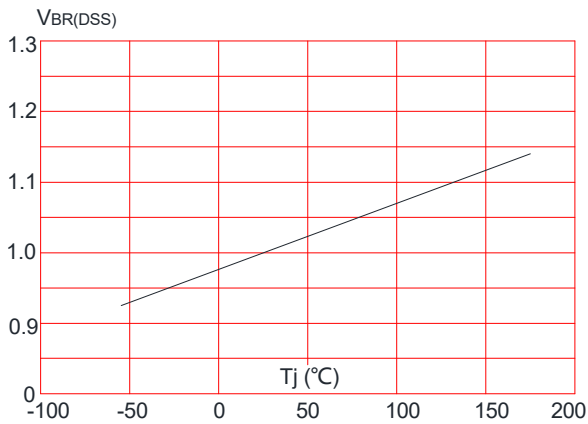
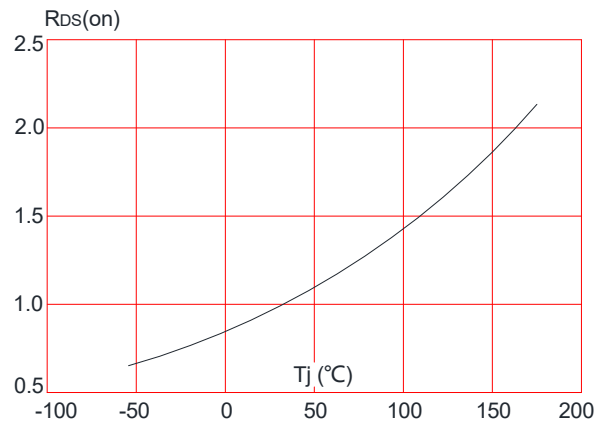
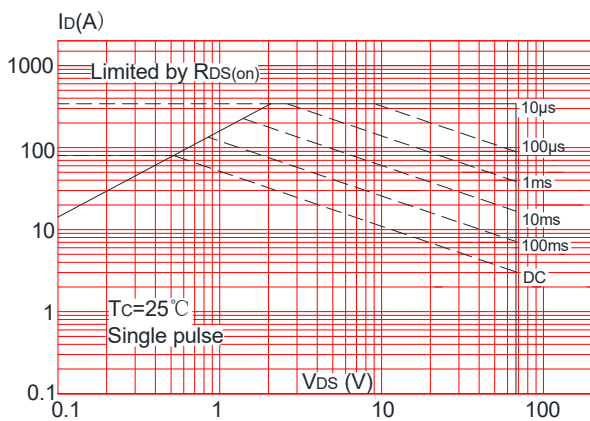
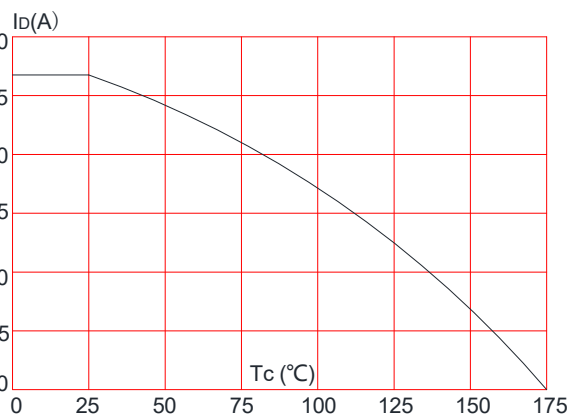
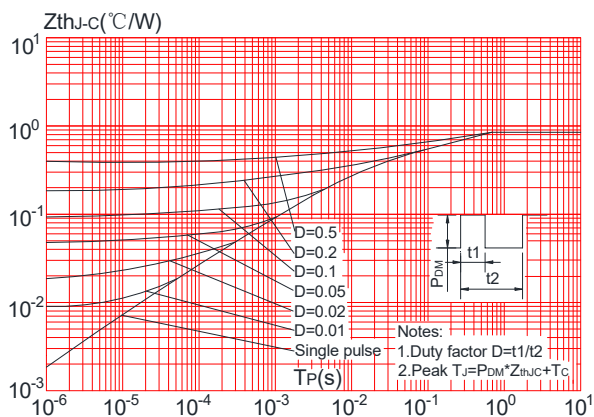
Figure 6: Capacitance Characteristics

Figure 7: Normalized Breakdown Voltage vs. Junction Temperature

Figure 8: Normalized on Resistance vs. Junction Temperature

Figure 9: Maximum Safe Operating Area

Figure 10: Maximum Continuous Drain Current vs. Case Temperature

Figure.11: Maximum Effective Transient Thermal Impedance, Junction-to-Case

Test Circuit

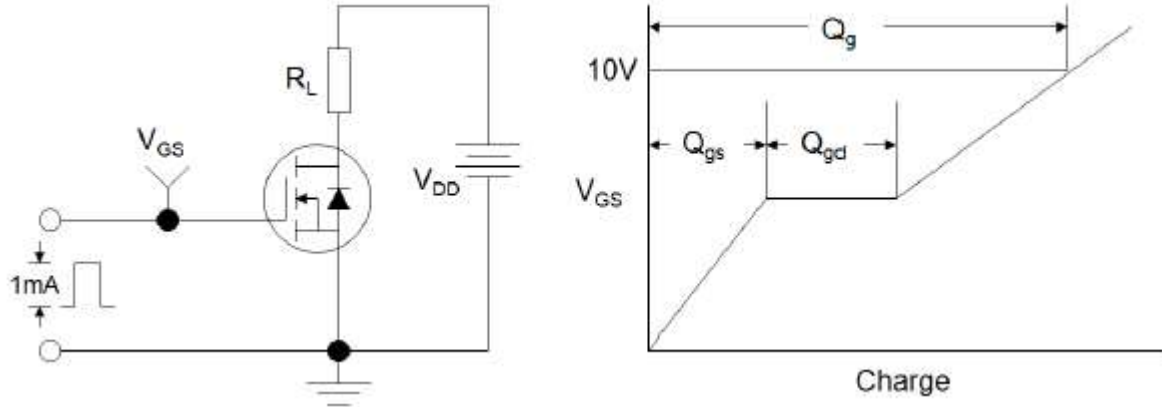

Figure1: Gate Charge Test Circuit & Waveform

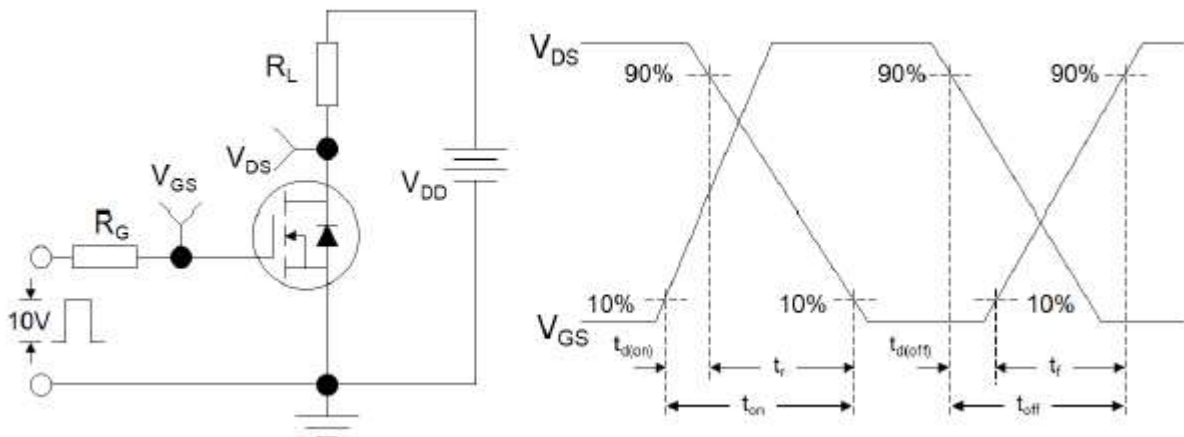

Figure 2: Resistive Switching Test Circuit & Waveforms

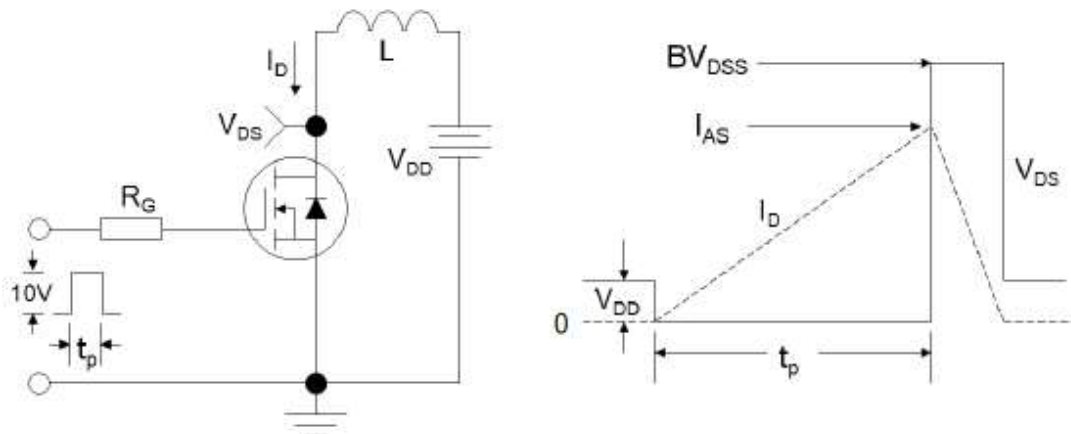
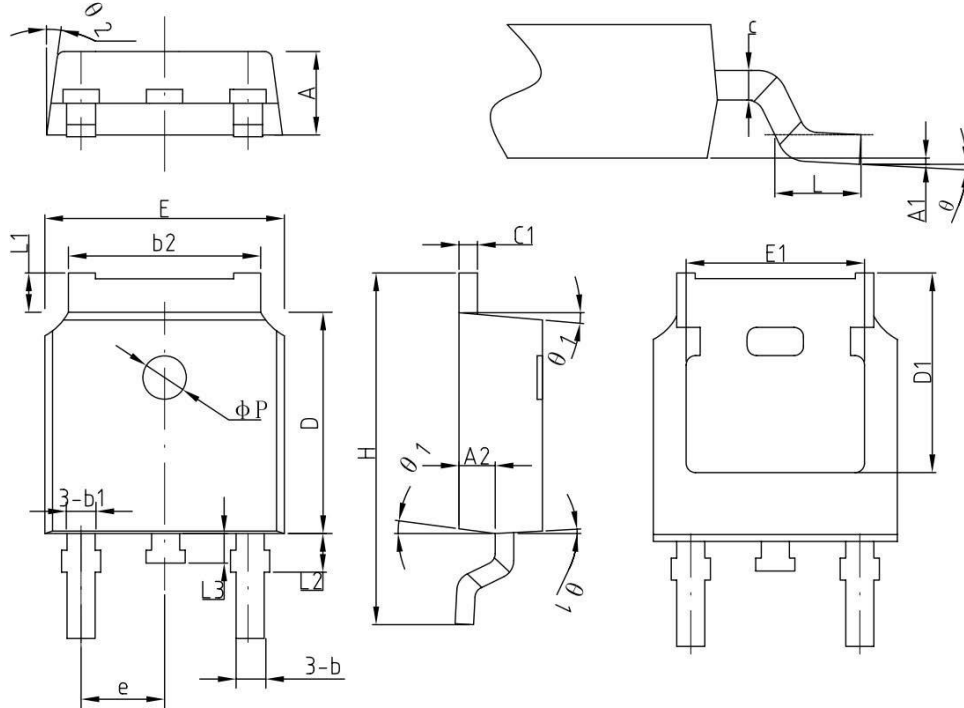

Figure 3: Unclamped Inductive Switching Test Circuit & Waveforms

Package Dimension

TO-252

Unit: mm



COMMON DIMENSIONS
 (UNITS OF MEASURE=MILLIMETER)

SYMBOL	MIN	NOM	MAX
A	2.2	2.30	2.38
A1	0	—	0.10
A2	0.90	1.01	1.10
b	0.71	0.76	0.86
b1		0.76	
b2	5.13	5.33	5.46
c	0.47	0.50	0.60
c1	0.47	0.50	0.60
D	6.0	6.10	6.20
D1	—	5.30	—
E	6.50	6.60	6.70
E1	—	4.80	—
e	2.286BSC		
H	9.70	10.10	10.40
L	1.40	1.50	1.70
L1	0.90	—	1.25
L2		1.05	
L3		0.8	
ϕP		1.2	
θ	0°	—	8°
$\theta 1$	5°	7°	9°
$\theta 2$	5°	7°	9°